



Project: _____ Type: _____
 Notes: _____ Catalog #: _____

PLUG-IN POWER SUPPLY SD-ACDC

DESCRIPTION

- LED Plug-in table top power supply
- Three prong power cord included
- Input: 100-247V AC, 1.5A, 50/60Hz
- Output: DC 24V, 3A
- Power supply contained within fully enclosed plastic case
- Indoor use only
- Class II rated
- RoHS, cUL Listed



DRAWING

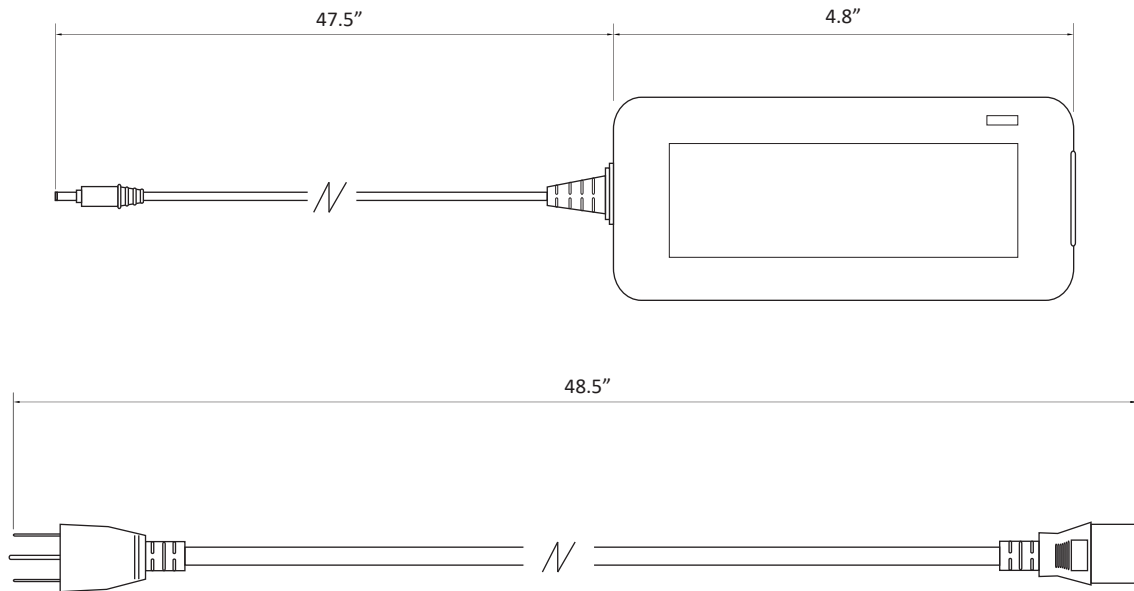

ORDERING INFORMATION

Series No.	Outout Voltage	Wattage
SD-ACDC	24=24V DC	72=72W

Weight

14 oz.

Package Dimensions

7.5" X 3.8" X 1.5"

Note: specification subject to change without notice

1622 Boundary Road, Burnaby, BC, Canada V5K 4V4

1.866.695.8966

