

LED SHOEBOX LIGHT BOLSBM

DESCRIPTION

Being an ideal replacement for conventional metal halide and high pressure sodium lighting fixtures, Blue Ocean's SBM Shoebox fixture considerably increases the energy efficiency, visibility and safety in outdoor applications such as: outdoor basketball courts, tennis courts, sports stadiums, school playgrounds, parking lots, roadways and parks. Utilizing high quality PHILIPS LUMILEDS LED modules, superior tempered glass optics and high performance MEAN WELL driver, this Shoe Box series is guaranteed to deliver high lumen efficiency, buzz and flicker free light and excellent colour uniformity. Constructed of a heavy duty Magnesium Alloy housing, BOLSBM series Shoebox achieves 25% faster heat dissipation than traditional Aluminum housings, which extends fixture lifespan and ensures lighting performance under extreme conditions. The fixture is IP65 rated to be installed in damp or wet locations and can operate against climate changes without cracking or peeling. Heat dissipation is optimized with an integral secondary heat sink.

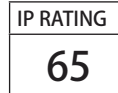

DRAWING

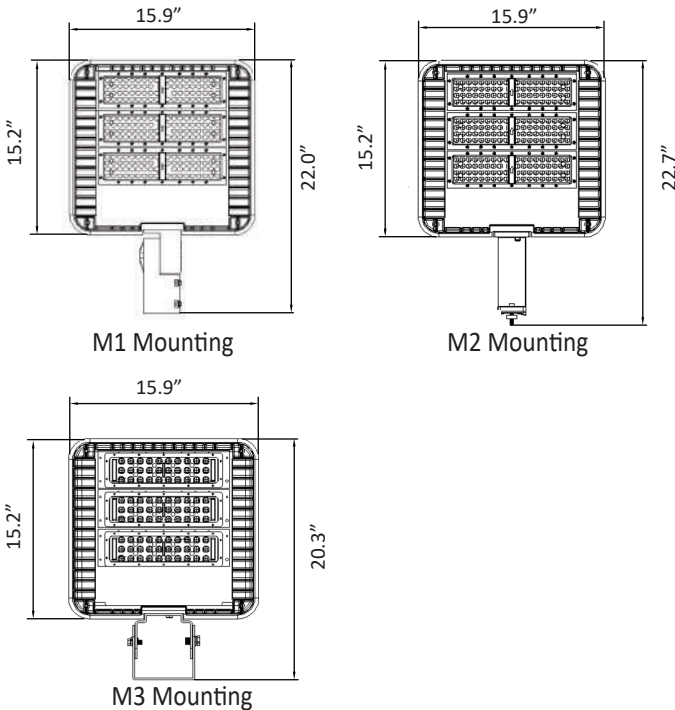

SPECIFICATION CHART

Model	BOLSBM150WHLL1M[1,2,3]XX
Voltage	100-277VAC
Wattage	150W
Replacement	400W HPS/MH
Lumen Output	19500-21000lm
Luminous Efficacy	130-140lm/W
CRI	>70
PFC	0.90
CCT	4000K 5000K 5700K
Light Distribution	85*150° (Type III)
Weight	26.5lbs
Finish	Black Magnesium Alloy
Operating Temp.	-40~40°C

ORDERING INFORMATION

Series No. BOLSBM	Wattage 150W=150W	Type HL=Type HL 100-277VAC	Lens L1=85*150° Type III	Mounting M1=Split Fitter (Round Pole) M2=Direct Arm Pole M3=Trunion	CCT 40=4000K 50=5000K 57=5700K	Control Blank=No Control PC=Photocell*	Protection Blank=No Protection SP=Surge Protector*
-----------------------------	-----------------------------	---	------------------------------------	--	--	---	---

MOUNTING TYPE A - ADJUSTABLE MOUNT

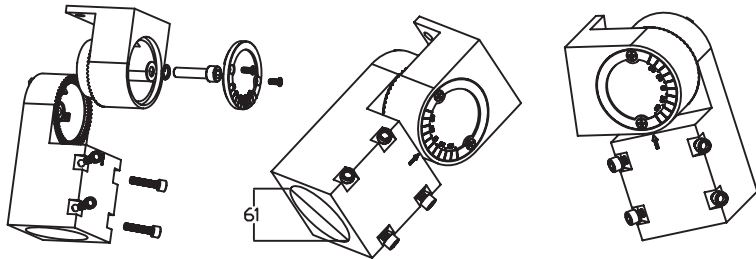

UNIT OF MEASUREMENT: MM

MOUNTING TYPE B - DIRECT MOUNT

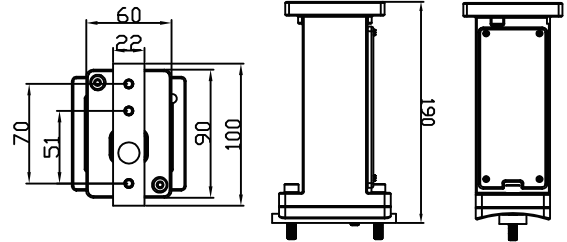
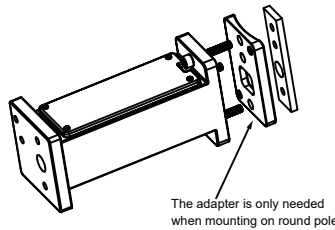

UNIT OF MEASUREMENT: MM

MOUNTING TYPE C - TRUNNION MOUNT

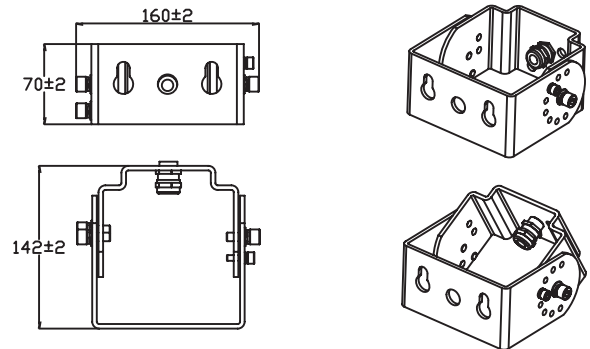
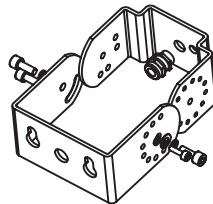

UNIT OF MEASUREMENT: MM

ACCESSORIES

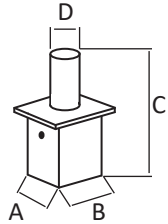

	D	A	B	C
A-1	60mm/2.36"	152.5mm/6.00"	152.5mm/6.00"	362mm/14.25"
A-2	60mm/2.36"	130mm/5.12"	130mm/5.12"	362mm/14.25"
A-3	60mm/2.36"	102mm/4.02"	102mm/4.02"	362mm/14.25"

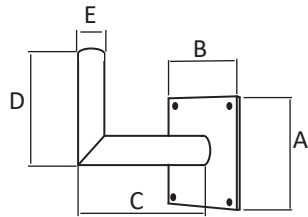

	E	A	B	C	D
B-1	60mm/2.36"	178mm/7.00"	178mm/7.00"	216mm/8.50"	204mm/8.03"

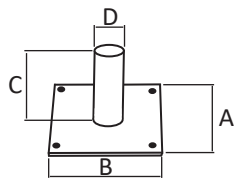

	D	A	B	C
C-1	60mm/2.36"	178mm/7.00"	178mm/7.00"	153mm/6.02"
C-2	57mm/2.24"	180mm/7.09"	100mm/3.94"	203mm/7.99"

PHOTOMETRIC SPEC

BLUE OCEAN LIGHTING™
BOLSBM150WHLL1M150
 20' Mounting Height

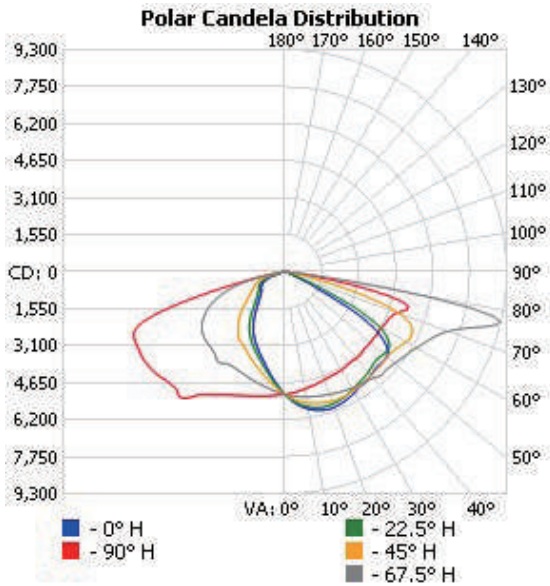

Illuminance at a Distance

Distance	Center Beam LUX	Beam Width
3.3ft	5,072 LUX	6.8 ft 20.0 ft
6.7ft	1,230 LUX	13.9 ft 40.6 ft
10.0ft	552 LUX	20.7 ft 60.6 ft
13.3ft	312 LUX	27.5 ft 80.7 ft
16.7ft	198 LUX	34.6 ft 101.3 ft
20.0ft	138 LUX	41.4 ft 121.3 ft

■ Vert. Spread: 92.0°
 ■ Horiz. Spread: 143.5°

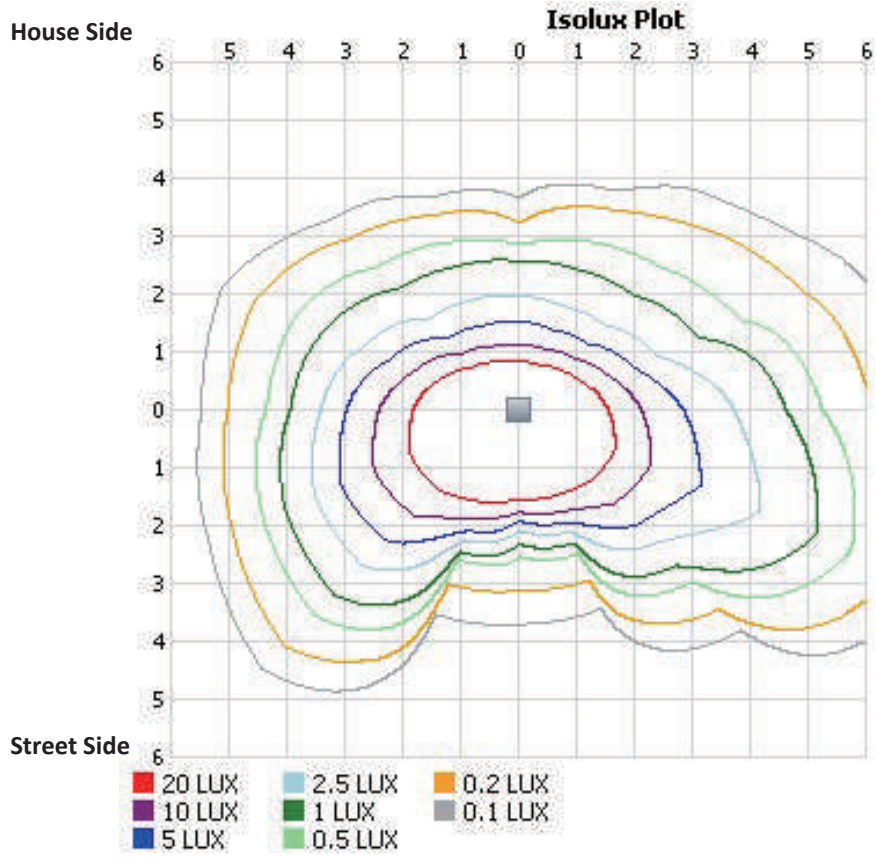

Mount Height: 20ft
 Grid Width: 120ft
 Total LLF: 1