

LED Round Panel Light BOLPAN

DESCRIPTION

Designed as an energy efficient, cost effective and aesthetically pleasing replacement for traditional grid lights and fluorescent fixtures, Blue Ocean's BOLPAN LED Round Panel Light series is a modern and stylish round shape slim panel with uniform downside light output. Constructed of anodized aluminum frame with white, black or silver finishing to match with specific interior design theme, this round panel light features quick and easy suspending installation. Utilizing super bright LED source and low voltage constant current driver, this high-performance Round Panel Light creates harmonious and uniform light with high energy efficiency, great color consistency and minimum luminous depreciation. Highly efficient thermal control system enables maximum heat dissipation for LED sources to consistently run cooler for stable performance and long lifespan. Perfect for use in office spaces, schools, hospitality, healthcare and other residential and commercial applications.

DRAWING

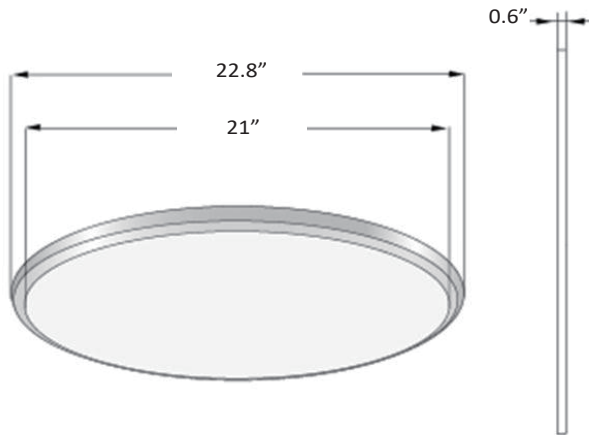

IP RATING
20



SPECIFICATION CHART

Model	BOLPAN-40W-XX-U60
Voltage	100-277VAC
Wattage	60W
Lumen Output	5000lm
CRI	>80
PFC	>0.95
CCT	3000K 4000K 5000K
Housing	Aluminum
Beam Angle	120°
Installation	Suspended Mount

ORDERING INFORMATION

Series No. BOLPAN	Wattage 60W=60W	CCT WW=3000K NW=4000K DW=5000K	Type U60	Finishing BLK=Black WHT=White
-----------------------------	---------------------------	--	--------------------	--