

LED SLIM CANOPY BOLCP

DESCRIPTION

With excellent performance, great energy-efficiency and ultra-slim design, Blue Ocean's BOLCP LED Slim Canopy Light series is designed to replace traditional metal halide, HID or fluorescent lighting fixtures in gas stations, convenience stores, drive through locations and parking garages. IP54 rated for protection against water, fixture is made up of a one-piece die-cast extruded aluminum housing with polyester powder-coated finish to resist rust and corrosion and a shock proof and UV resistant polycarbonate lens. Working in the environment of 120-277VAC, this Slim Canopy Light utilizes high-end CREE LED chips and superior driver to achieve excellent performance with high luminous efficacy, colour uniformity, minimized lumens depreciation and long life. It features easy and quick installation in terms of surface mount or 3/4" suspended mount, and built-in motion sensor is available for special order.

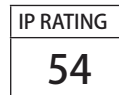
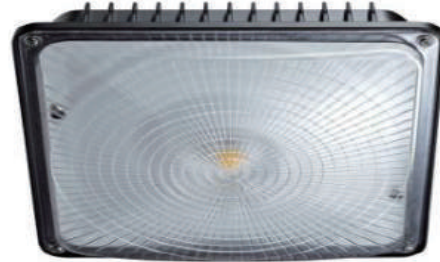

DRAWING

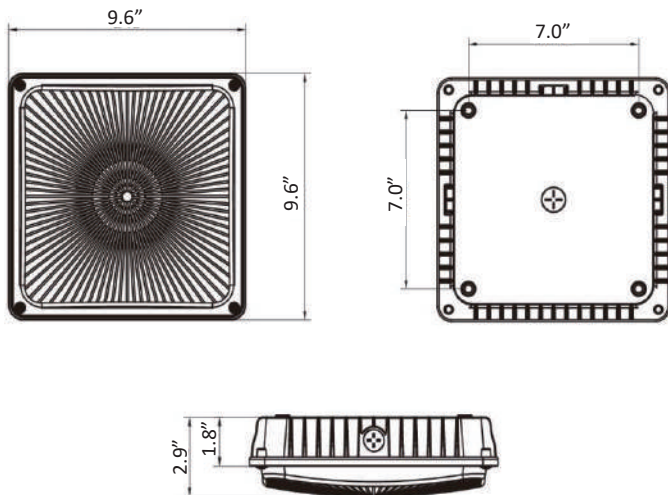

SPECIFICATION CHART

| | |
|-----------------------|--------------------|
| Model | BOLCP-XX-27V |
| Voltage | 120-277VAC |
| Wattage | 45W 65W |
| Replacement | 100W 150W HPS/MH |
| Lumen Output | 4000lm 6500lm |
| CRI | >70 |
| PFC | 0.95 |
| CCT | 4000K 5000K |
| Beam Angle | 160° |
| THD | <20% |
| Finish | Dark Bronze |
| Operating Temperature | -40~40°C |

ORDERING INFORMATION

| | | | | | | |
|----------------------------|--------------------------------------|----------------------------------|--------------------------------------|---|--|--|
| Series No. BOLCP | Wattage 45W=45W 65W=65W | Voltage 27V=120-277VAC | CCT 40K=4000K 50K=5000K | Finish D=Dark Bronze W=White | Sensor M=Motion Sensor* Blank=No Sensor | Lens F=Frosted Lens* Blank=Clear Lens |
|----------------------------|--------------------------------------|----------------------------------|--------------------------------------|---|--|--|

PHOTOMETRIC SPEC

BLUE OCEAN LIGHTING™

BOLCP45W27V40KD

15' Mounting Height

BOLCP45W27V40KWF

15' Mounting Height

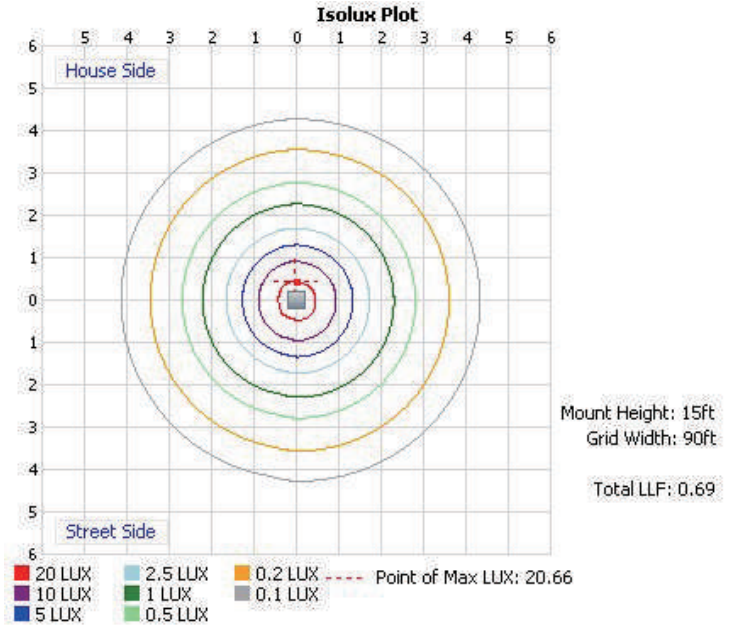
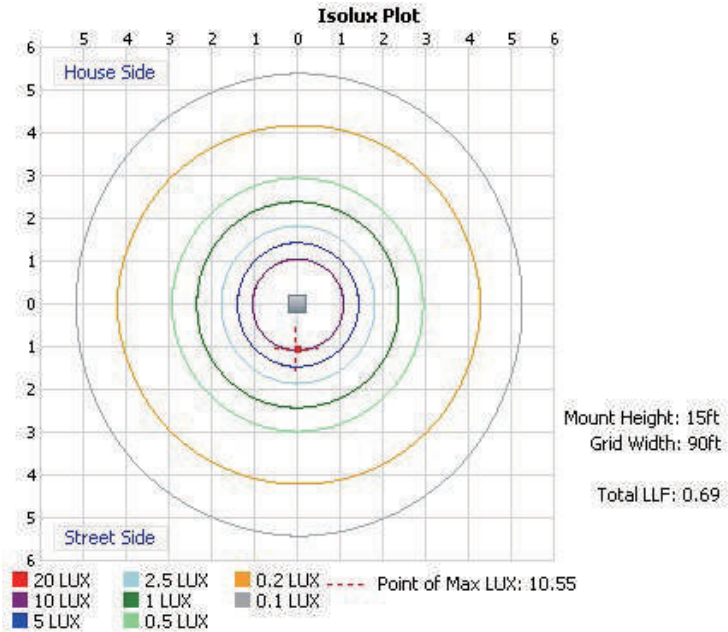
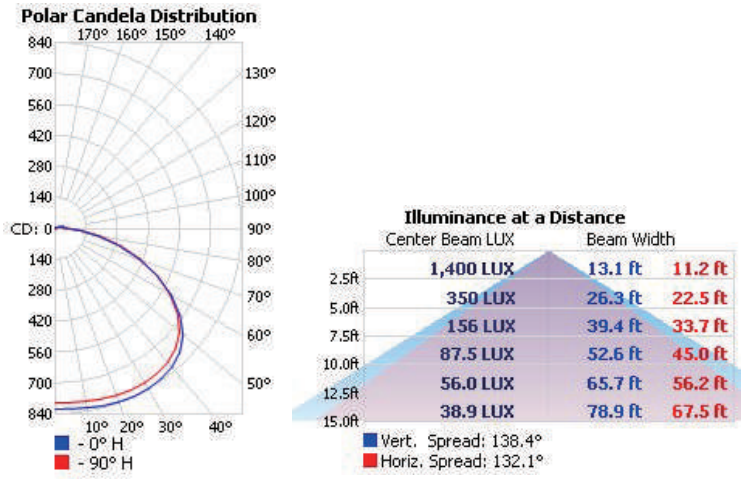
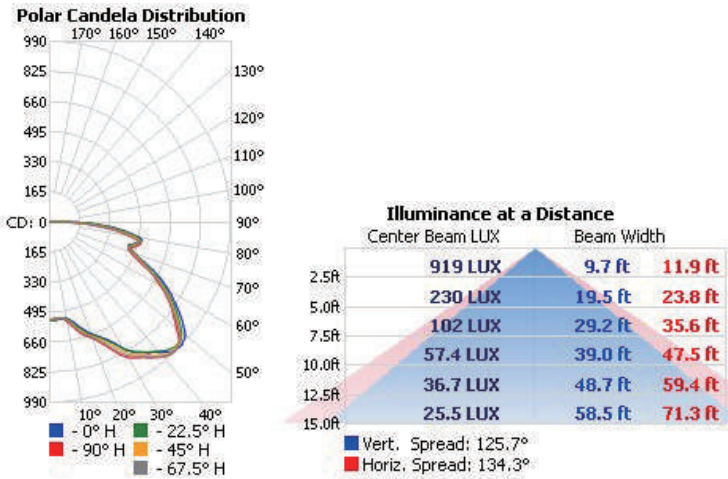

PHOTOMETRIC SPEC

BLUE OCEAN LIGHTING™

BOLCP65W27V40KD

15' Mounting Height

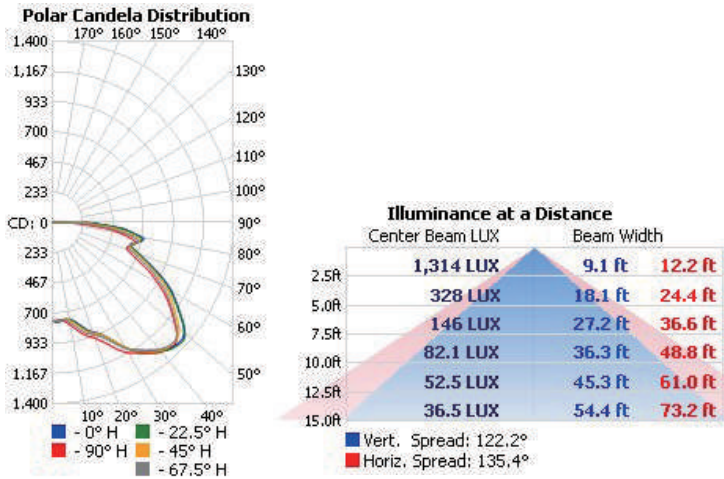

BOLCP65W27V40KWF

15' Mounting Height

