

INSTALLATION MANUAL

LED STRIP LIGHT

WARNING

1. To avoid electric shock, disconnect power at the source prior to installation.
2. The installation needs to be conducted by a certified electrician to ensure proper installation.
3. If there are problems with the fixture, turn off power and do not attempt to repair unless you are a certified electrician.
4. The electrical rating of this product is 12VDC or 24VDC. Please refer to the information on package. The required rewiring length is 5 metres (12V) or 10 metres (24V).
5. Make sure total wattage does not exceed 80% of the driver's max load.
6. Read label information carefully to ensure proper input voltage for this product.

Installation

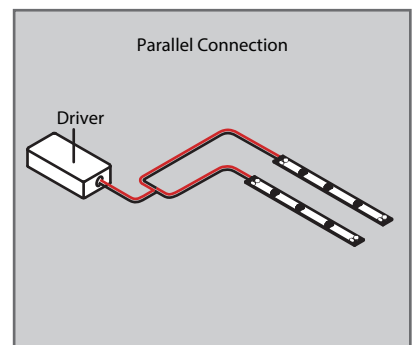
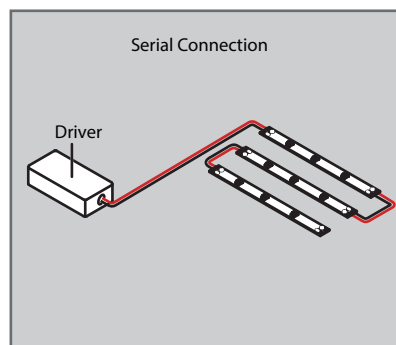
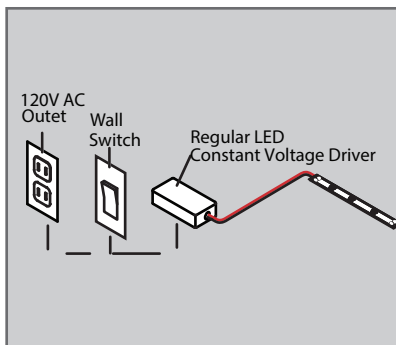
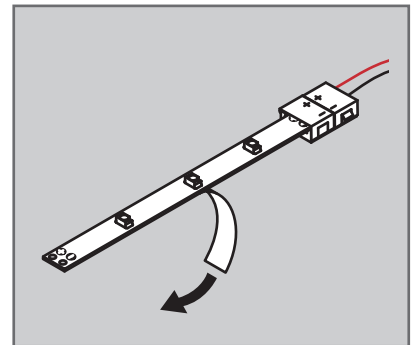
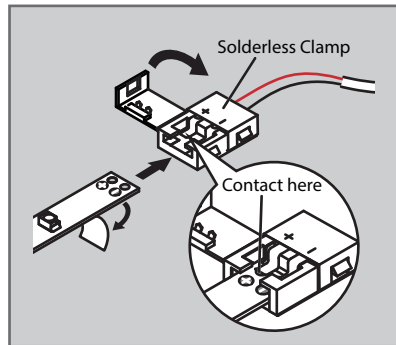
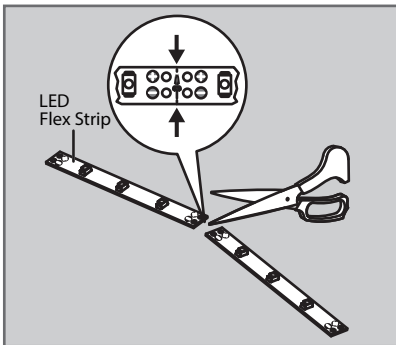

INSTALLATION MANUAL

LED STRIP LIGHT

Driver & Dimming

Low-voltage Dimming

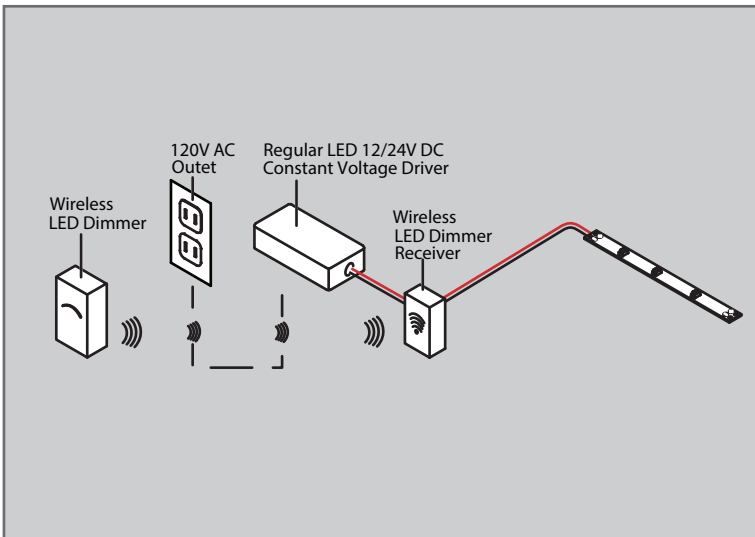

Line-voltage Dimming

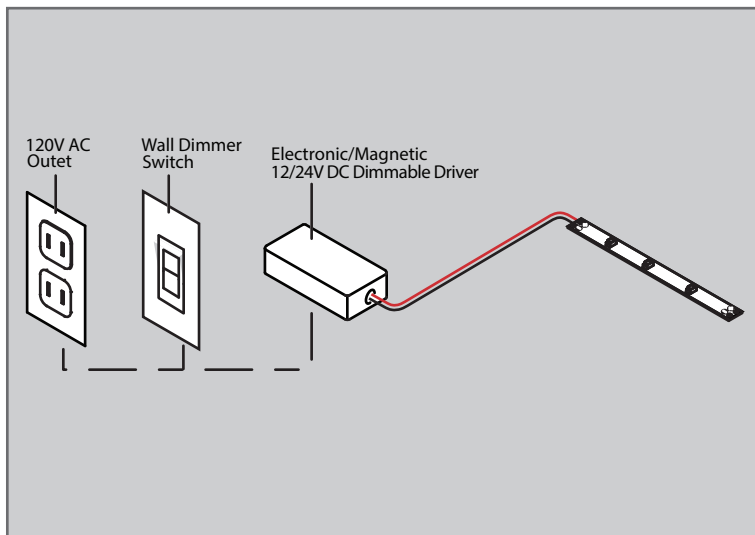

INSTALLATION MANUAL

LED STRIP LIGHT

Mounting Options for Cabinet

