

INSTALLATION MANUAL

LED CANOPY LIGHT

 **WARNING**

1. To avoid electric shock, disconnect power at the source prior to installation.
2. The installation needs to be conducted by a certified electrician to ensure proper installation.
3. If there are problems with the fixture, turn off power and do not attempt to repair unless you are a certified electrician.
4. The electrical rating of this product is 120-277VAC or 347VAC (refer to product label to determine).
5. Read label information carefully to ensure proper input voltage for this product.

Installation-Surface Mounted with J-box

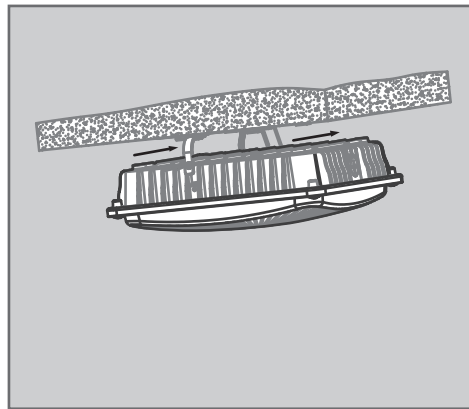
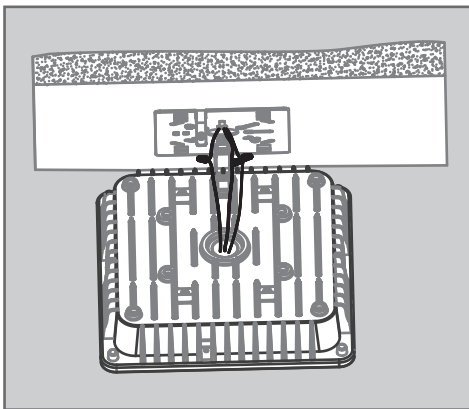
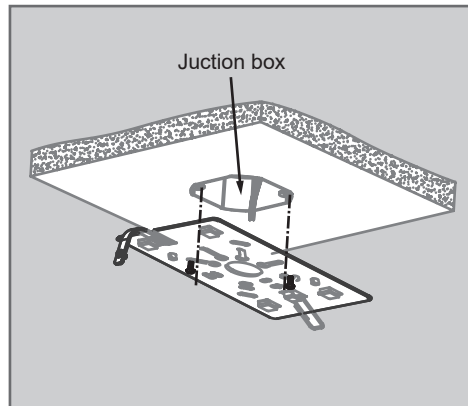
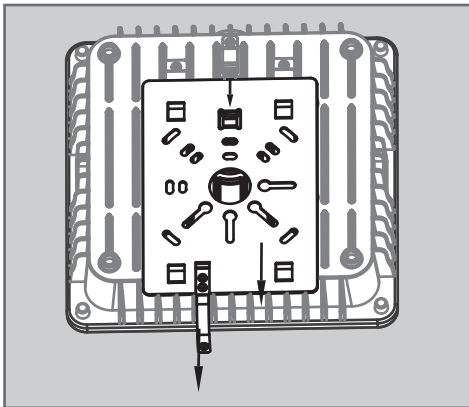

INSTALLATION MANUAL

LED CANOPY LIGHT

Installation-Pendent with 3/4 inch Conduit

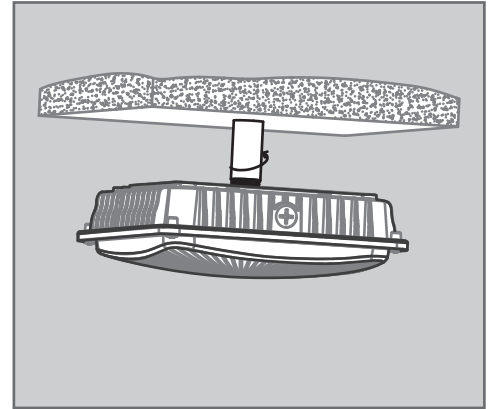
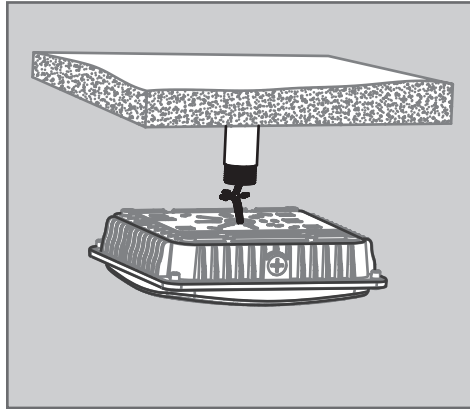
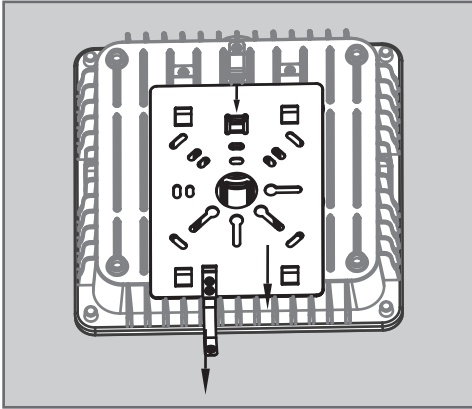

Installation-Surface mount

